

The Beadery® Springtime Treasures - Irises

Decorate with this fun and easy to make window decoration.

Use this pattern to get you started with purple irises, or get creative and choose colors to match your own color scheme.

Materials needed:

82	9x6 mm Barrel Pony Beads	Transparent Blue
65	9x6 mm Barrel Pony Beads	Green
32	9x6 mm Barrel Pony Beads	Purple
4	9x6 mm Barrel Pony Beads	Yellow
1	12" Chenille Stem	Any Color
3 yd (2.8 m)	Thread	White

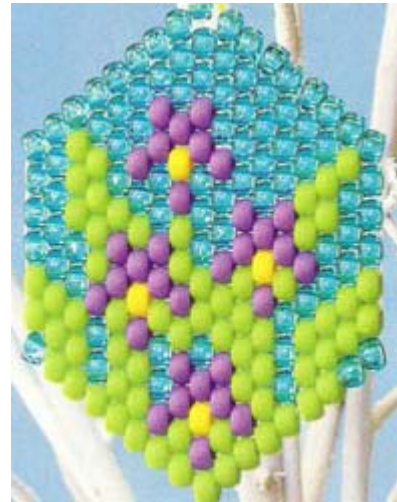

Other items and tools needed:

ruler, scissors, craft glue, tape, large crewel needle

Helpful Hints:

- It is easiest to make banner if you have a color printer, and can print out the pattern (below) without reducing it.
- Read all instructions before beginning.
- Align beads with pattern sheet after each row.

Instructions:

Step 1: On a computer with access to the internet and a color printer, download this project and print the full color pattern included at the end of the instructions.

Step 2: Cut a 3 yd. (2.8 m) piece of thread and thread the needle.

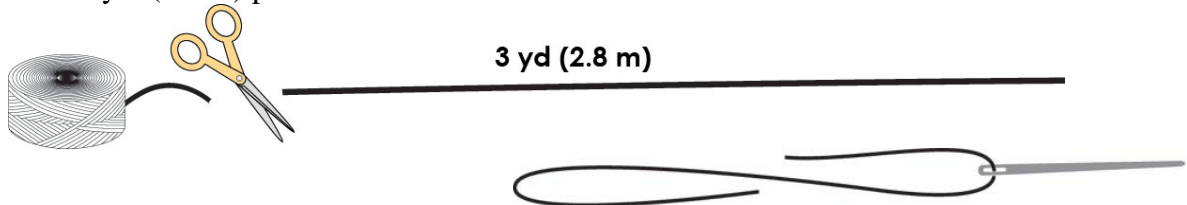

Step 3: Tape the pattern to your work surface and tape the thread down leaving a 36" (90 cm) tail to the left of row 1. String the following beads onto the thread that will be used to make rows 1 and 2:

- 2 transparent blue pony beads
- 2 green pony beads
- 1 transparent blue pony bead
- 2 purple pony beads
- 1 yellow pony bead
- 2 purple pony beads
- 5 transparent blue pony beads
- 1 green pony bead
- 1 transparent blue pony bead

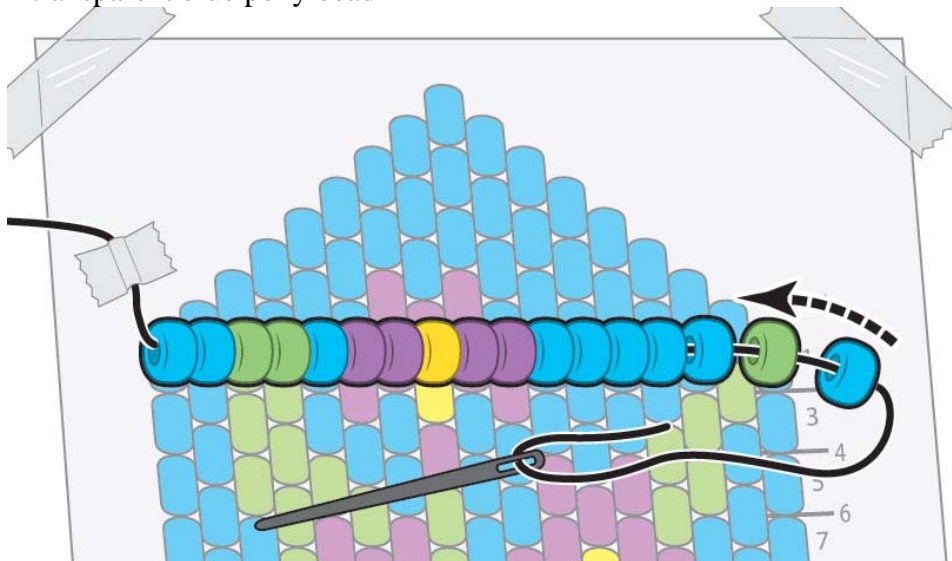

Step 4: Slide the chenille stem through every other bead starting with the transparent blue bead on the outside to form two rows.

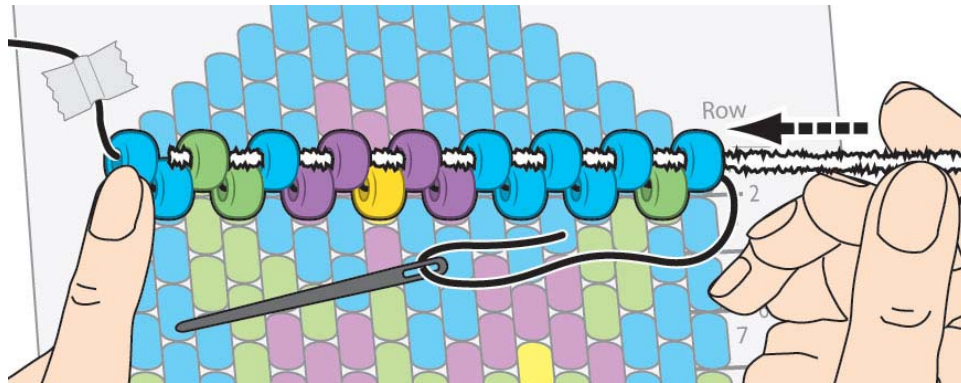

Step 5: Tape the chenille stem to the work surface at row 1, aligning beads to the pattern.

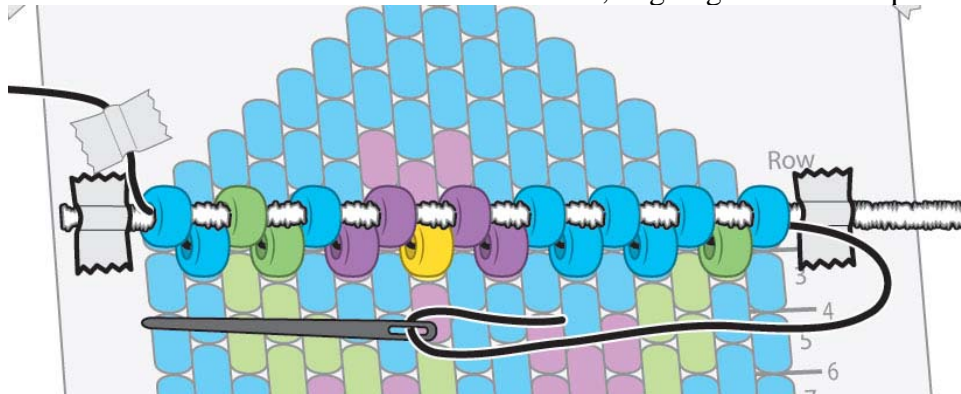

Step 6: String the first bead of row 3 on the thread and then pass the needle through the last bead in row 2 to secure.

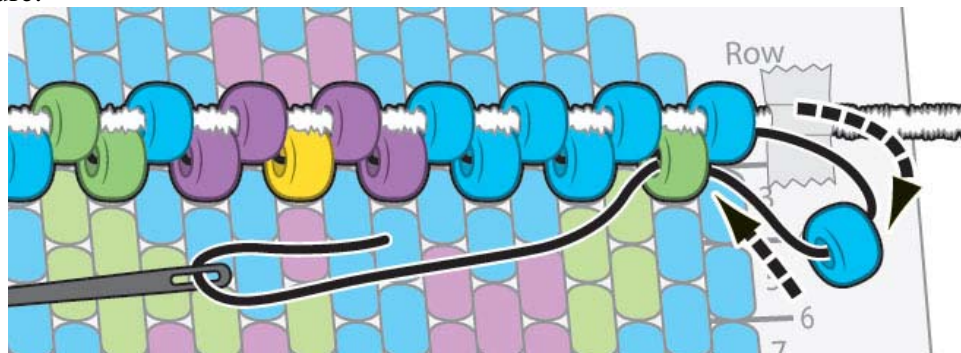

Step 7: Continue adding and tightly securing beads one at a time to the end of row 3.

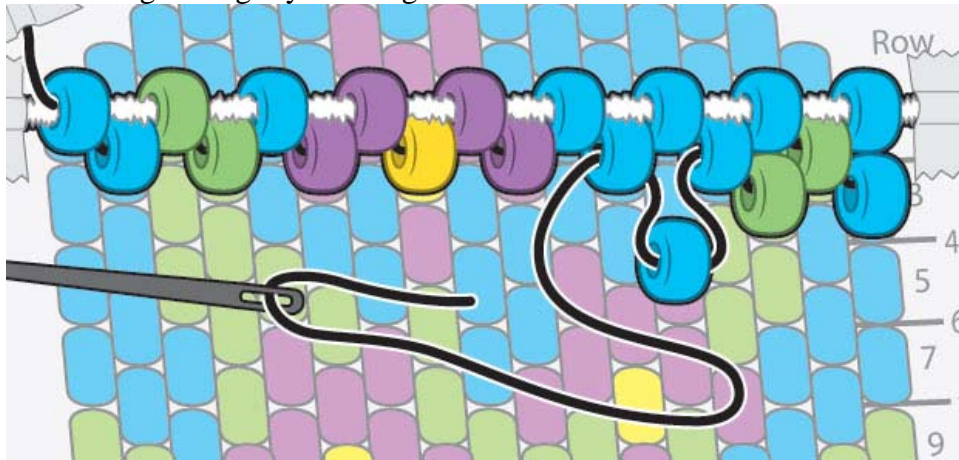

Step 8: Remove the tape from the thread and tie the threads together with a square knot.

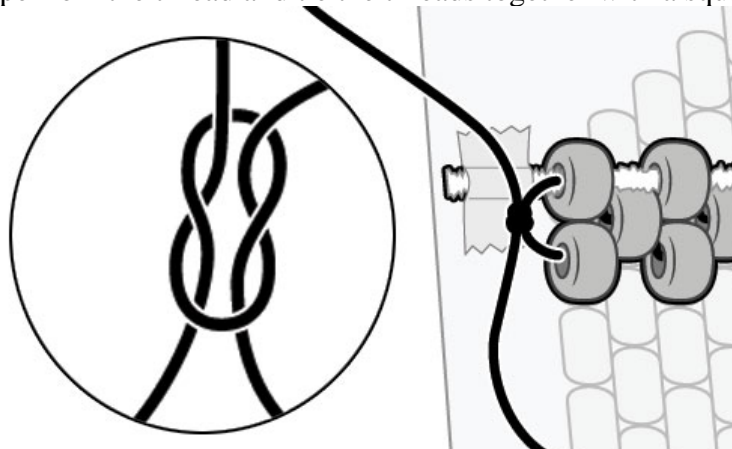

Step 9: Re-tape the thread and pass the needle back through the last bead added. Complete rows 4 and 5, keeping the project aligned with the pattern for a quick color reference.

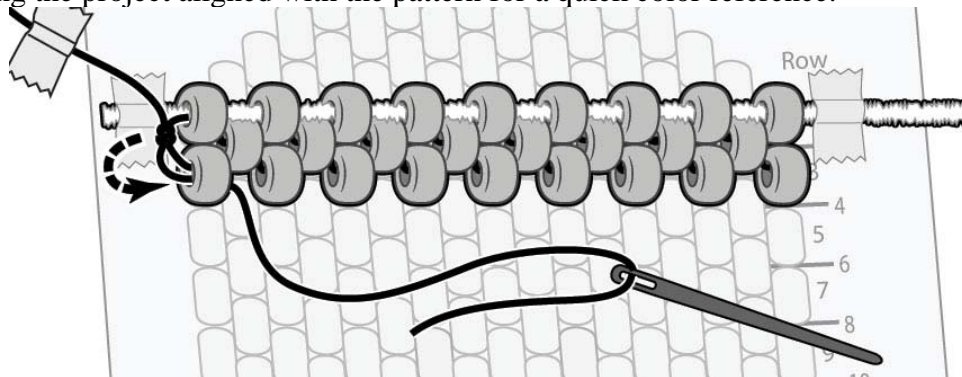

Step 10: Pass the needle through the thread on the outer edge as shown in the diagram.

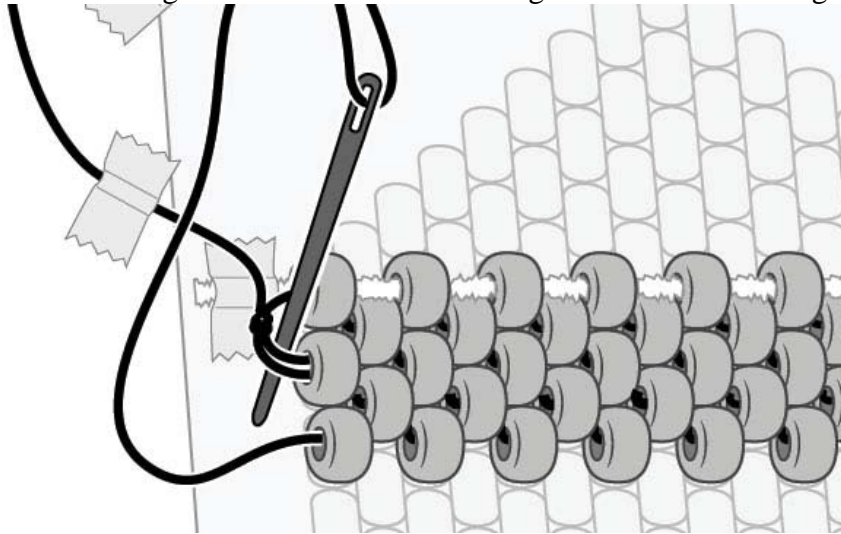

Step 11: Go back through the last bead added and continue the project through row 14. Be sure to pass the needle through the thread on the outer edge each time you reach the left side.

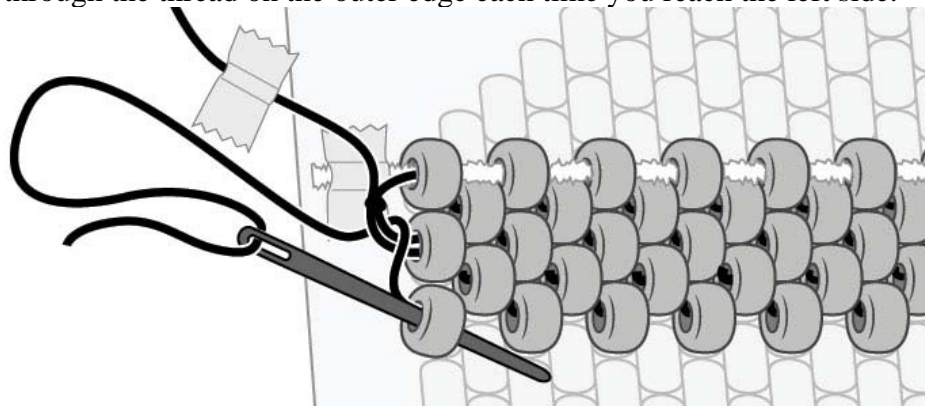

Step 12: After the last bead in row 14, pass the needle up through the end bead of row 13 and then through the outer edge thread.

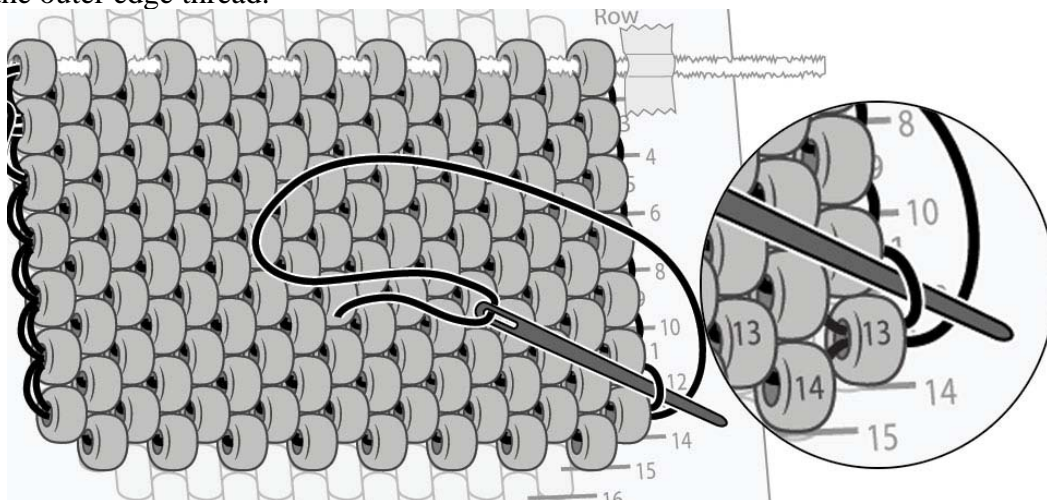

Step 13: Pass the needle through the last bead in each of the last two rows.

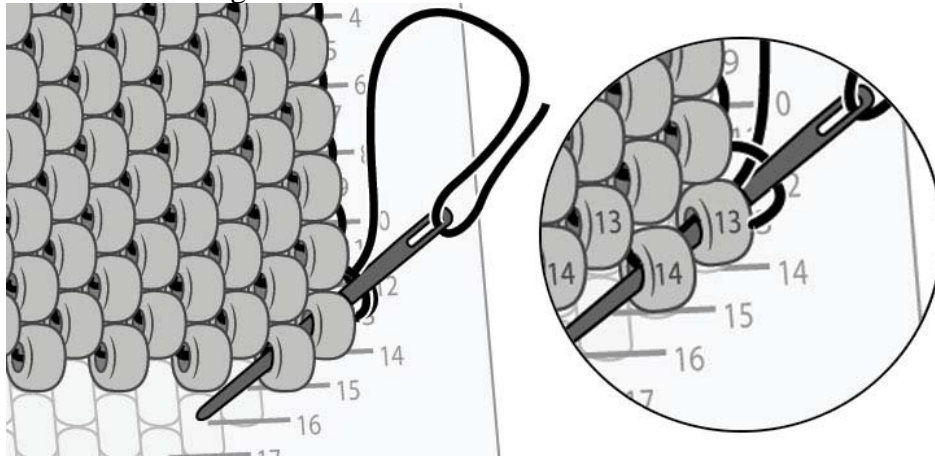

Step 14: Continue across the row following the pattern. After the last bead on the left side, go up through the end bead of the previous row and around the thread as shown.

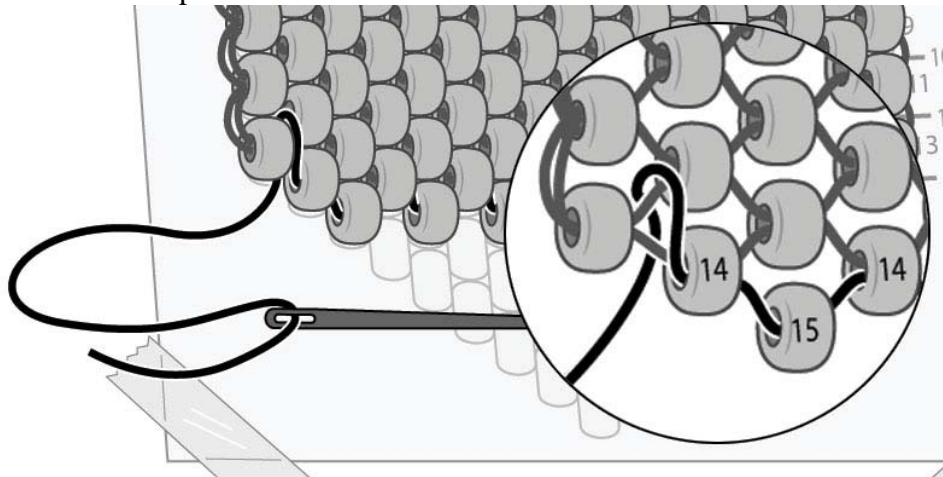

Step 15: Pass the needle back through the end beads of the previous two rows and continue building the next row.

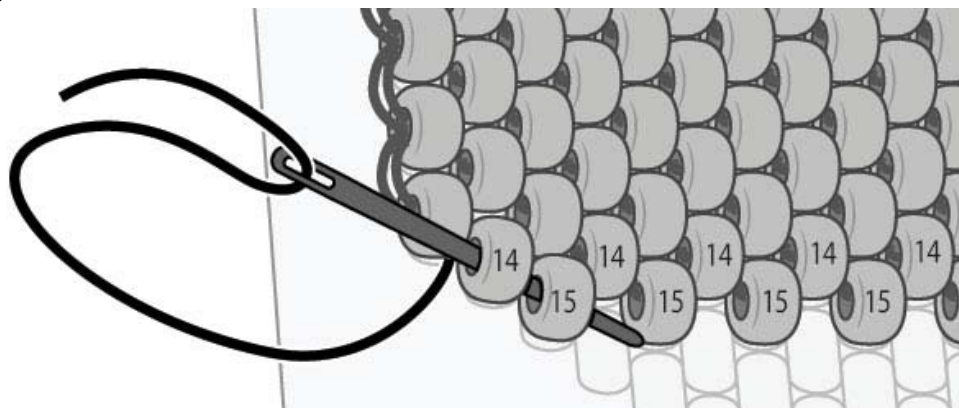

Step 16: After the last bead on the right side, go up through the end bead of the previous row, then around the thread and back through both beads as shown in the diagram.

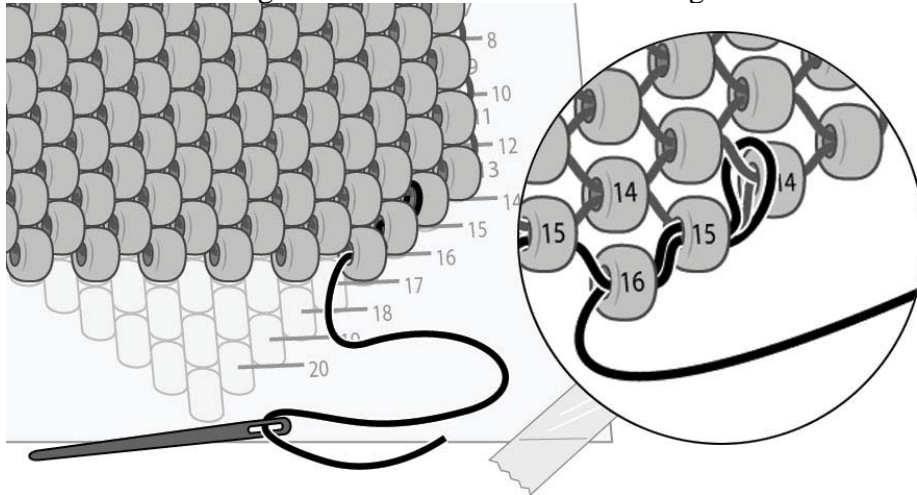

Step 17: Continue building through row 20, tapering each side as described in Steps 14-16.

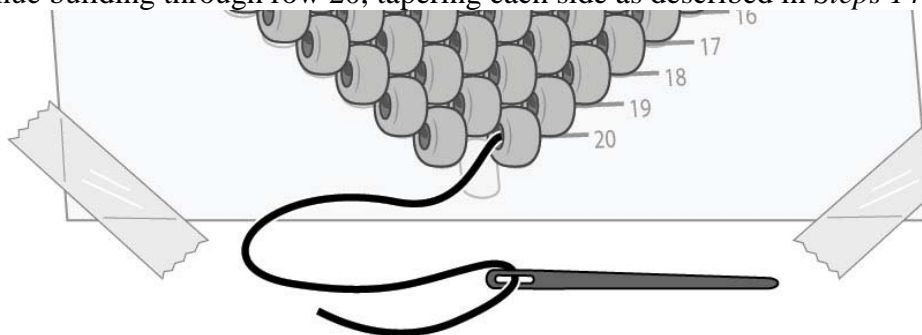

Step 18: To end, add the last bead and go through the end bead of previous row. Make the end knot by passing the needle around the thread and back through the loop as shown. Make sure the beads are nested together and pull tight. Repeat to make a second knot.

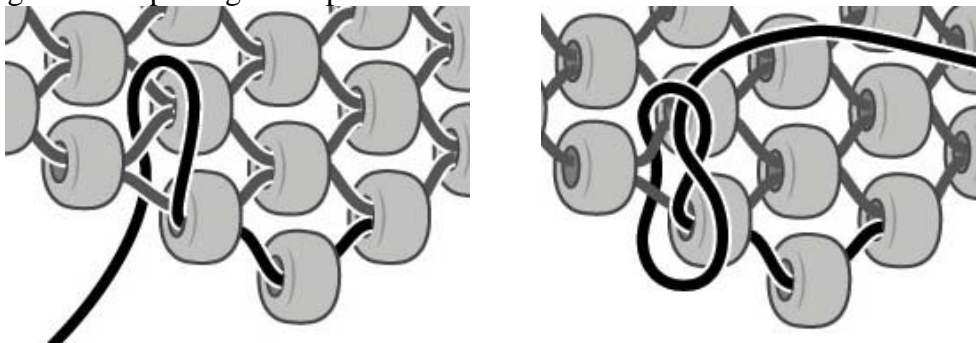

Step 19: Glue the knot with craft glue and trim off excess thread.

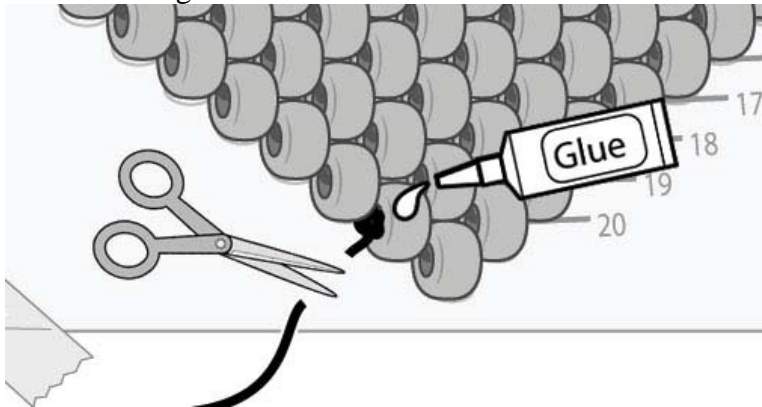

Step 20: Rotate the pattern and project. Remove the tape from the thread beside row 1 and thread the needle. Pass the needle through the end bead on the chenille.

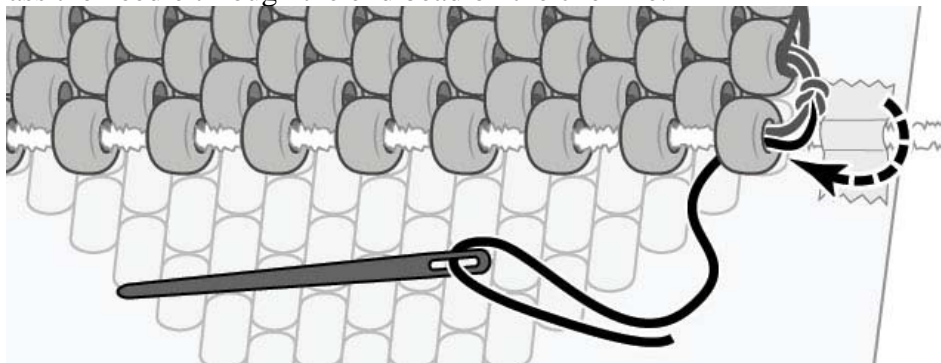

Step 21: Build the remaining rows, tapering each side as in Steps 14-16. Complete the ornament as in Steps 18-19 and remove the chenille stem.

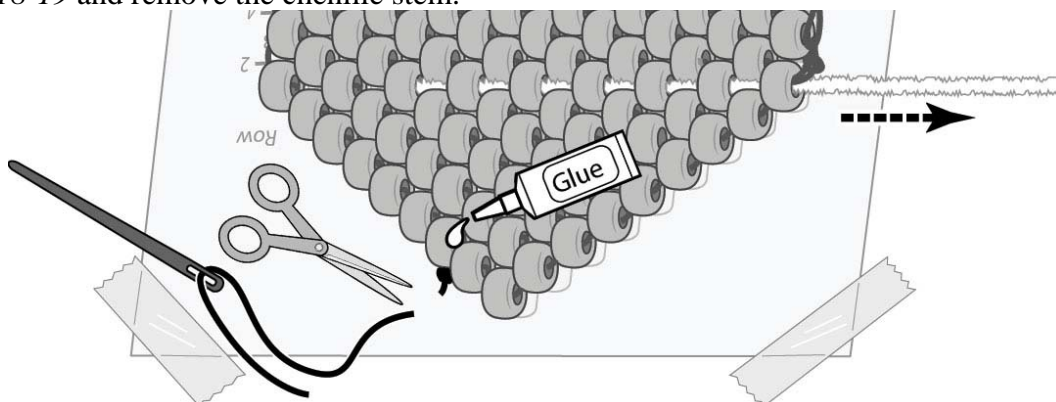

Step 22: The ornament may be suspended from a wire, thread or monofilament that is passed through the bead at the top point.

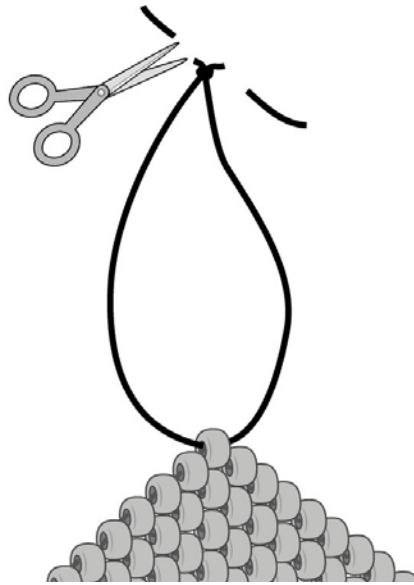



5383 – Irises Pattern Sheet

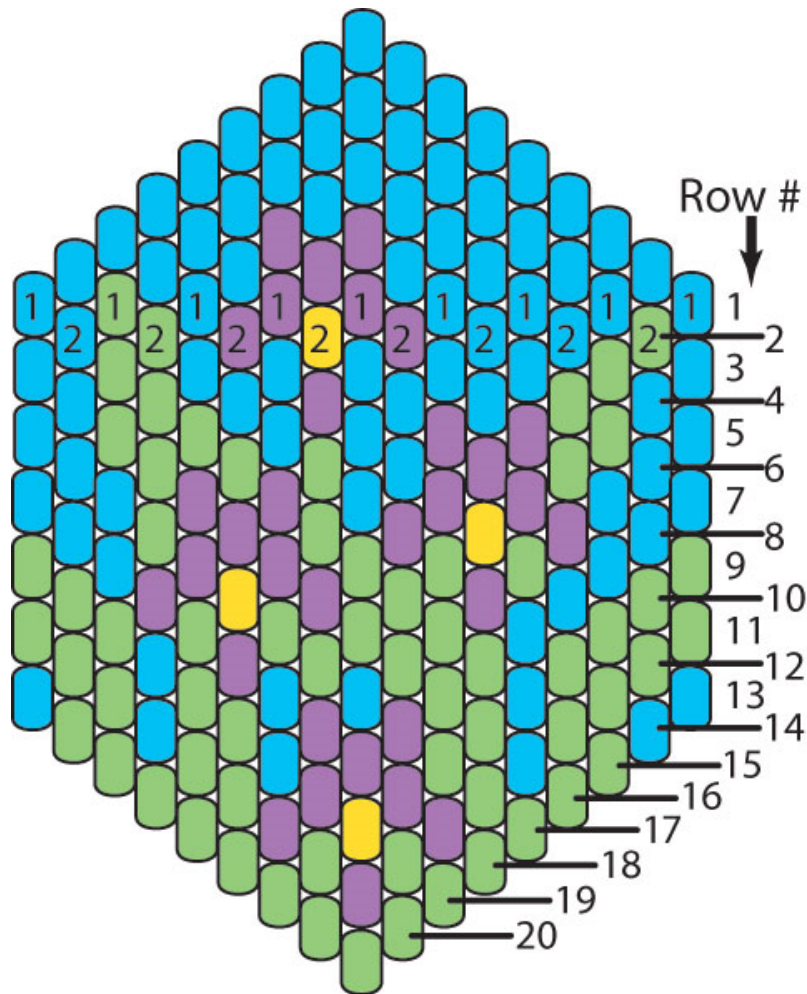

Bead Count

<u>Color</u>	<u>Qty</u>
Transparent Blue	82
Green	65
Purple	32
Yellow	4